

AVON
PROTECTION

EXOSKIN®-S1

An OPEC CBRNE
Partnership



EXOSKIN-S1 SUMMARY

Customizable

Available in different configurations and sizes for suitability for all mission types. - ¼ zip or full zip available with hook & loop fastening for Improved integration with body armor.

Integration

A fully integrated CBRN ensemble option from a single supplier that delivers the highest chemical, biological and antiviral protection levels combined with advanced wearer comfort

Ergonomically designed with user in mind

Ergonomically shaped sleeves and legs to reduce the amount of fabric when limbs are bent in turn reducing the chance of snagging incidents.



Reduced burden

30% lighter than conventional CBRN systems, reducing physiological burden on the user due to use of ACF and its properties.

Designed for maximum protection

Underarm panel from hem to elbow, preventing hem lift when arms are raised - freedom of movement without the hem lifting, retaining the overlap between the jacket and trouser, allowing the user to safely carry out their mission without their protection being compromised. ACF lined skirt to prevent vapor ingress when worn, maximizing the level of protection for the user.

Durable

Addition of knee and elbow pockets which are ACF lined, allows for the addition of supplemental padding and more puncture resistance in areas of high load or abrasion so provides higher levels of protection to the user.



EXOSKIN-S1
Key Design USPs

CUSTOMIZABLE



Avon Protection's EXOSKIN-S1 comes in two variants, a jacket and trouser ensemble.

Available in different configurations and sizes to ensure suitability for all mission types.

¼ zip or full zip available with hook & loop fastening for Improved integration with body armor.

EXOSKIN-S1 offers multiple camo patterns and colour design formulations to help users avoid detection and attack in hostile environments.

- **Suit designs – two piece**
- **Zip – Full zip / quarter zip**
- **Colors – Standard colors as per swatches, special patterns can be requested**

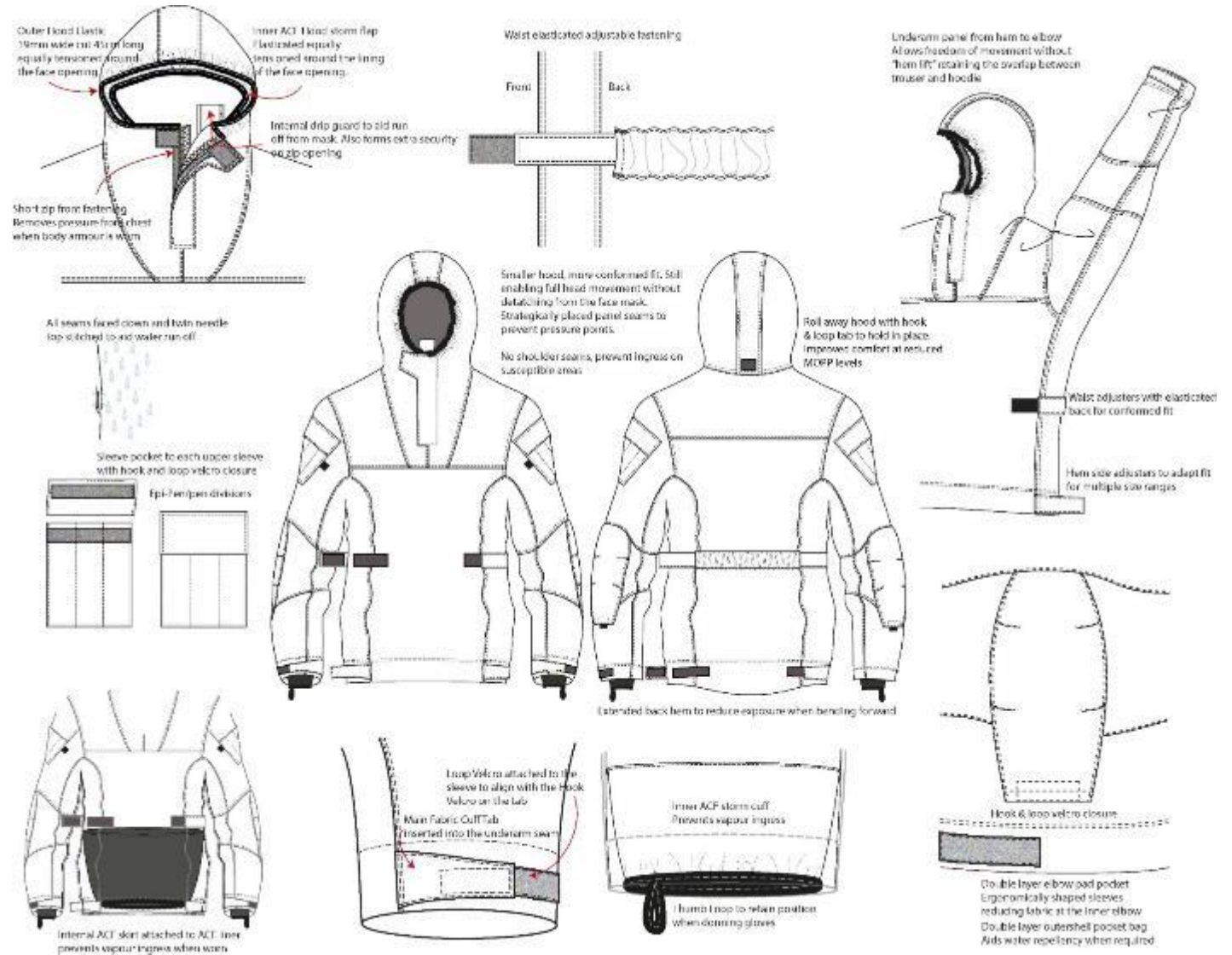

CUSTOMIZABLE



Avon Protection's EXOSKIN-S1 comes in two variants, a jacket and trouser ensemble.

Available in different configurations and sizes to ensure suitability for all mission types.

¼ zip or full zip available with hook & loop fastening for Improved integration with body armor.

EXOSKIN-S1 offers multiple camo patterns and colour design formulations to help users avoid detection and attack in hostile environments.

- **Suit designs – two piece**
- **Zip – Full zip / quarter zip**
- **Colors – Standard colors as per swatches, special patterns can be requested**

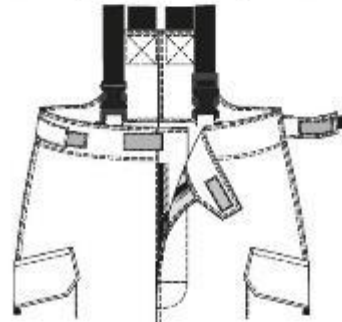
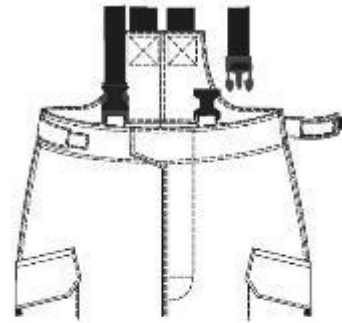

Extended fly fastening with durable Zip fastening and under storm guard. Side adjustable fastening

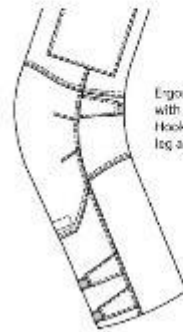

Ergonomically shaped leg with knee pad pocket. Hook & loop velcro lower leg adjusters

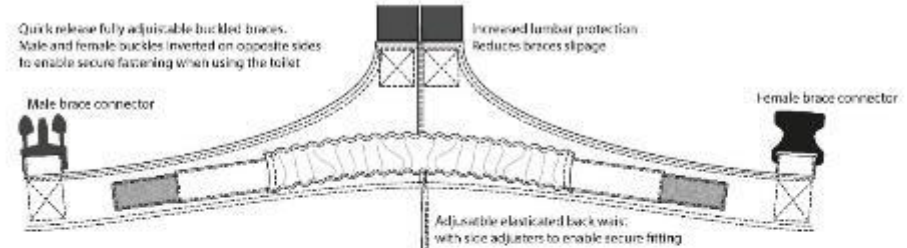

Quick release fully adjustable buckled braces. Male and female buckles inverted on opposite sides to enable secure fastening when using the toilet

Increased lumbar protection. Reduces braces slippage

Male brace connector

Female brace connector

Adjustable elasticated back waist with side adjusters to enable secure fitting

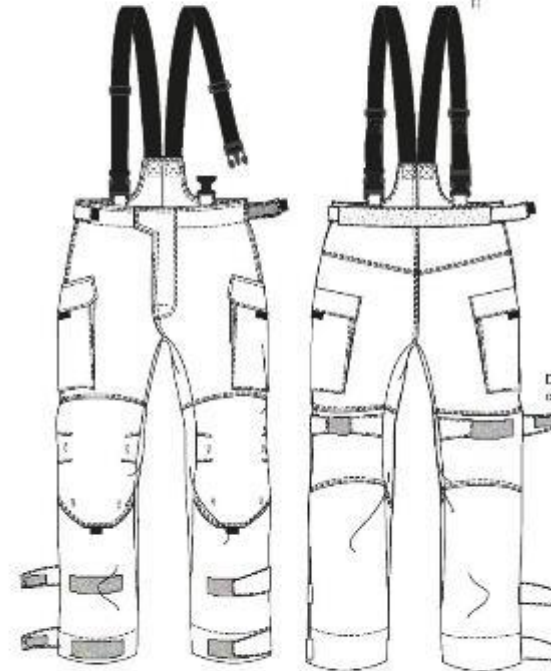

Knee adjusters to ensure knee pad position stays in place

Double layer of outer shell on knee pocket and seat area



Inner leg gaiter with stirrup

All seams faced down and twin needle top stitched to aid water run off

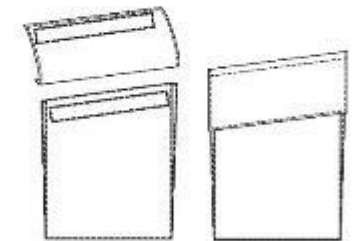

Large cargo pockets with ACF lining. Bellows to both sides for extra room. Full flap closure with hook & loop velcro. Positioned across side seam for ease of access when worn with the Hoodie.

REDUCED BURDEN & INTELLIGENT MATERIALS



30% lighter than conventional CBRN systems, reducing physiological burden on the user:

Use of Activated Carbon Fabric (ACF) instead of spherical absorbent beads which are conventionally heavier than ACF. ACF gives the garment lightweight and breathable properties and as it resembles standard textiles that are used in everyday apparel manufacture, it means it can be utilised in normal production processes.

ACF has very high level of comfort due to its lower weight, excellent air permeability, less water vapour resistance and flexibility without compromising chemical protection, enabling better mobility for the user to carry out their mission effectively.



SUIT SIZING

Size	Height (cm)	Height (In)	Chest (cm)	Chest (In)	Waist (cm)	Waist (In)	Inside Leg (cm)	Inside Leg (In)
Small/Short	165 - 173	65 - 68	84 - 92	33 - 36	80 - 88	31 - 34	74	29
Medium/Short			92 - 100	36 - 39	88 - 96	34 - 37		
Large/Short			100 - 108	39 - 42	96 - 104	37 - 41		
X-Large/Short			108 - 116	42 - 46	104 - 112	41 - 44		
2XL/Short			116 - 124	46 - 49	112 - 120	44 - 47		
3XL/Short			124 - 132	49 - 52	120 - 128	47 - 50		
Small/Regular	173 - 180	68 - 71	84 - 92	33 - 36	80 - 88	31 - 34	79	31
Medium/Regular			92 - 100	36 - 39	88 - 96	34 - 37		
Large/Regular			100 - 108	39 - 42	96 - 104	37 - 41		
X-Large/Regular			108 - 116	42 - 46	104 - 112	41 - 44		
2XL/Regular			116 - 124	46 - 49	112 - 120	44 - 47		
3XL/Regular			124 - 132	49 - 52	120 - 128	47 - 50		
Small/Long	180 - 188	71 - 74	84 - 92	33 - 36	80 - 88	31 - 34	84	33
Medium/Long			92 - 100	36 - 39	88 - 96	34 - 37		
Large/Long			100 - 108	39 - 42	96 - 104	37 - 41		
X-Large/Long			108 - 116	42 - 46	104 - 112	41 - 44		
2XL/Long			116 - 124	46 - 49	112 - 120	44 - 47		
3XL/Long			124 - 132	49 - 52	120 - 128	47 - 50		

SUPPORTING DOCUMENTS

BROCHURE

- Typical overview
- Includes technical data and size guide
- Available on asset vault and Showpad now

USER GUIDE

- Includes donning and doffing instructions, storage conditions etc
- Will be available closer to launch

SALES PRESENTATION

- Will be available by end Jan on asset vault and Showpad

FAQs

- Details about materials used, shelf-life, wash cycles etc
- Will be available by end Jan

COMPETITOR COMPARISON

- Comparison of EXOSKIN-S1 with Blucher, Ouvry, MIRA suits
- Will be available by end Jan

PRICING

- Pricing available internally. Ask Justin for more info.

SUIT SAMPLES

- 20 samples delivered to HPW – 10 ¼ zip and 10 full zip.
- Military rated product – requires Export license

PROMO VIDEO

- Launch video available from w/c 15/1/24

